





Overview of functions and devices

| Function | Inserts | Design cover | | | |
|----------|---------|--|---|---|--|
| | |  |  |  | |
| | | System M System Design System Basis OCTOCOLOR | 5348... 5361.. 5397.. 5385.. 5391.. | 5347... 5362.. 5374.. 5365.. 5364.. | 5349... 5358.. 5375.. 5371.. 5372.. |

Room temperature control unit

| | | | | | |
|---|---|---|---|---|---|
| <ul style="list-style-type: none"> - For electromotive valve drives which are de-energised closed - 1 x make contact - Differential gap 0.5 K - Temperature range approx. 5-30 °C - Connection for time-controlled temperature reduction at night by approx. 4 K - With one-way switch and control lamp - With thermal recirculation |  | Room temperature control insert with switch 536302 (AC 230 V) 536304 (AC 24 V) | ■ | | |
| <ul style="list-style-type: none"> - For electromotive valve drives which are de-energised closed or de-energised open - 1 x changeover contact - Differential gap approx. 0.5 K - Temperature range approx. 5-30 °C - With thermal recirculation |  | Room temperature control insert with changeover contact 536400 (AC 230 V) 536401 (AC 24 V) | | ■ | |
| <ul style="list-style-type: none"> - For electrical underfloor heating with NTC sensor - Differential gap approx. 1 K - Temperature range approx. 10-50 °C - Separate connection for time-controlled temperature reduction at night by approx. 5 K |  | Floor thermostat insert with switch 537100 (AC 230 V) | | | ■ |

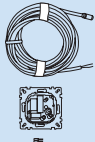
3

Room temperature control unit insert with switch
Art. no. 5363..

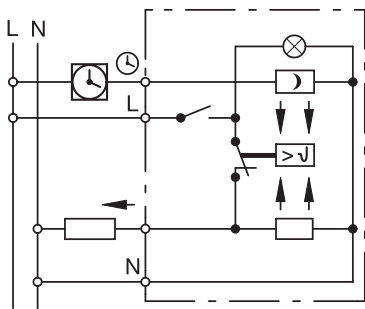

Room temperature control insert with changeover contact
Art. no. 5364..

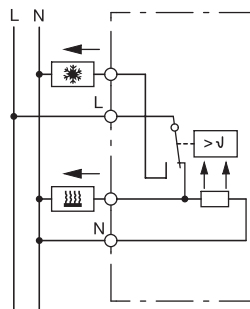

Floor thermostat insert with switch
Art. no. 537100

